

Smart heating solution

Comap Smart Home

Installation manual



comap

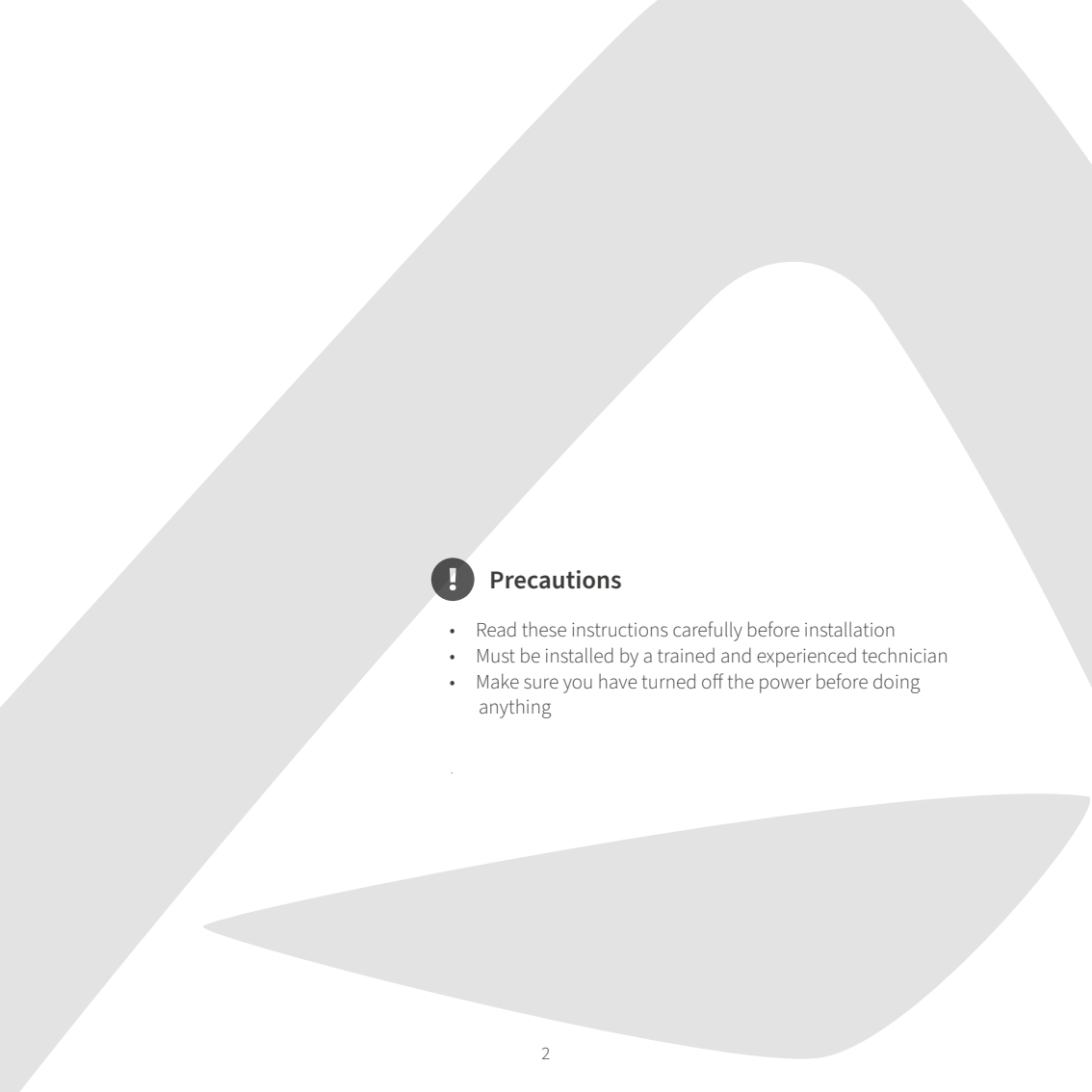

Precautions

- Read these instructions carefully before installation
- Must be installed by a trained and experienced technician
- Make sure you have turned off the power before doing anything

Table of contents

COMPATIBILITY	4
PACK CONTENTS	4
HOW THE DEVICE WORKS.....	5
THERMOSTAT	6
RECOMMENDATIONS FOR INSTALLATION.....	8
INSTALLATION	9
ON/OFF CONTACT : REPLACING A 4 WIRES THERMOSTAT	12
ON/OFF CONTACT : FIRST INSTALLATION	18
HEATING TEST	23
SPECIFICATIONS	26

COMPATIBILITY

The new smart thermostat solution from COMAP is compatible with most heating systems .

	On/Off contact
Gas heating	●
Oil heating	●
Wood heating	●
Heat pump	●
Electric heating (dry contact)	●
Electric heating (control wire)	

Check your compatibility at <https://boutique.comapsmarthome.com/fr/content/9-test-de-compatibilite>

PACK CONTENTS

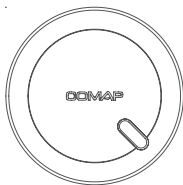

1x thermostat

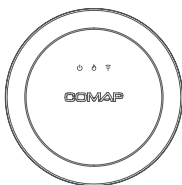

1x heating module



1x gateway



3x AAA batteries

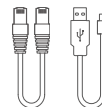

1x usb cable
1x RJ45 cable

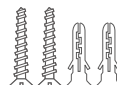
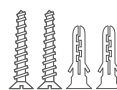

Screws and
wall anchors

HOW THE DEVICE WORKS

- 1 The **thermostat** is attached to the wall in a living area (e.g. the living room)

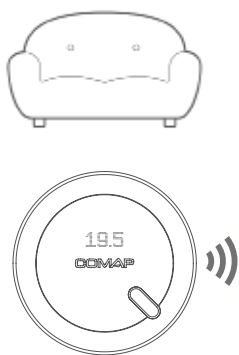

- 2 Connect the **gateway** to the internet modem / router

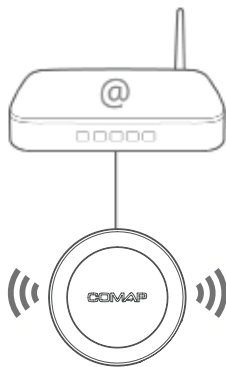

- 3 The **heating module** is wired to the heating system

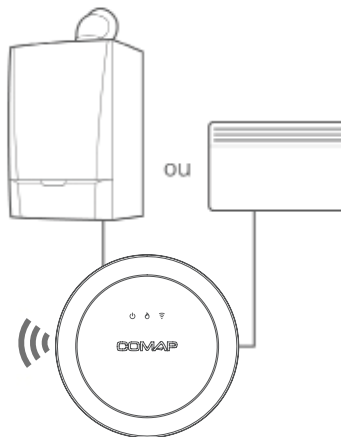

The three devices communicate with each other via radio waves (868MHz). The maximum distance between the gateway, the module(s) and the thermostat depends on the structure of your home (thickness of walls and building materials used) and the radio environment (presence of high-voltage power lines, overhead wires, devices that transmit radio waves). As an indication: in a new building in an urban environment, a distance around 10 m can be achieved.

THERMOSTAT

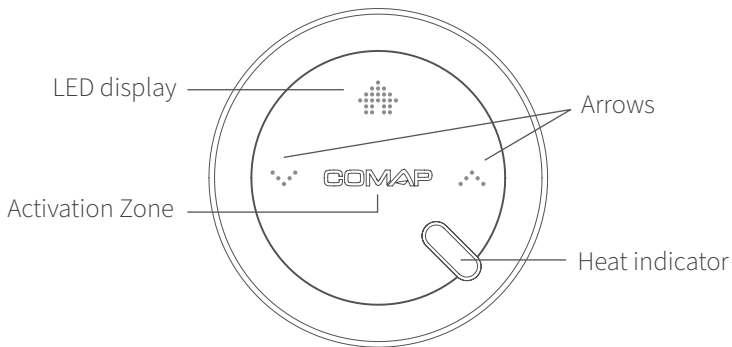

CONTROL

COMAP

You can wake up the thermostat by touching the activation area with the palm of your hand



The setpoint temperature can be set using the arrows

AT INSTALLATION



Updating, please be patient.









Pairing with the module



Restart

STARTING UP

						
<i>Welcome</i>	<i>Heating command</i>	<i>Stop command</i>	<i>Room Temperature</i>	<i>Setpoint Temperature</i>	<i>Heating off</i>	<i>Heating in progress</i>

ERROR CODES

		
1 <i>Problem with pairing</i>	2 <i>Communication problem</i>	3 <i>Disconnection</i>

- 1** If there is a pairing problem, bring the thermostat at the closest of the heating module and wake up the thermostat.
- 2** In the event of communication problems:
 - Disconnect the gateway from the modem and reconnect it; the two gateway LEDs must be lit and steady.
 - Remove the heating module from the holder and put it back; the right and left LEDs must be lit.
- 3** If the thermostat is disconnected and doesn't take pairing, contact Customer Service or check the help center to solve the transmission problem.

RECOMMENDATIONS FOR INSTALLATION

Where to install the COMAP Smart Home thermostat ?

Make sure that the thermostat is installed in a living area, the temperature it will measure there should be representative of the housing.

Recommended locations :

- In an occupied room, usually in the living room
- Do not install against an outside wall or in draughty spaces
- Between 1.2 and 1.5 m from the ground
- Keep away from doors, wall cupboards or other objects that may interfere with the presence detection sensor.
- Place the thermostat in a place where it cannot be exposed to direct sunlight.
- If you have pets, place the thermostat away from furniture they can sit on so that they are not detected by the presence detection sensor.

INSTALLATION

1 Connect the gateway

Connect the gateway to the internet router with the two supplied cables (RJ 45 and USB)

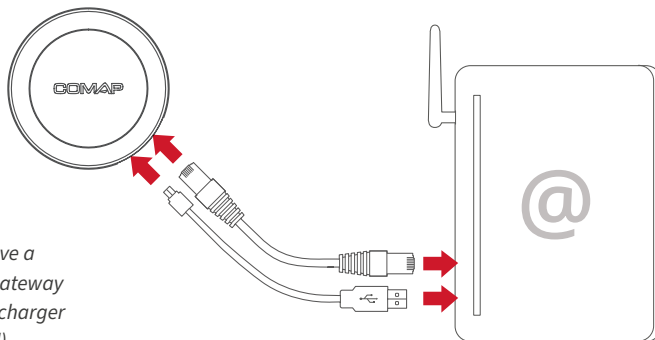

Note : If the modem does not have a USB port, you can connect the gateway to the mains using a 5V DC USB charger / minimum 200mA (not supplied).

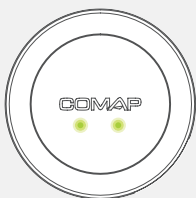

The two LEDs of the gateway should be on and be fixed :

- The left light indicates the gateway is well powered
- The right light indicates a good internet connection.

2 Remove the battery protection tab from thermostat.

Once powered up, the thermostat screen shows a check mark.

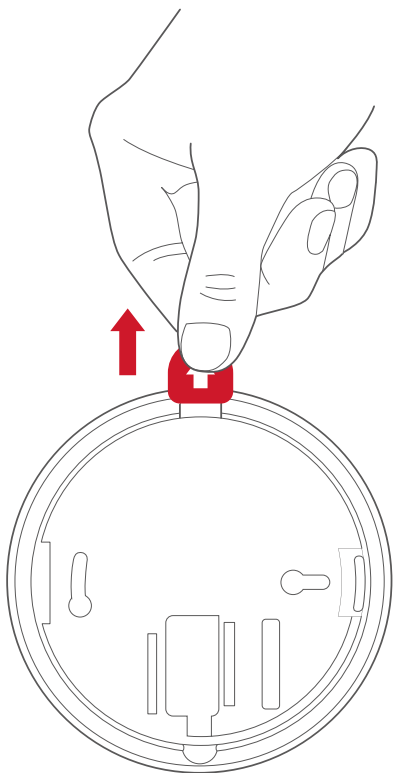

A symbol indicating that the product is starting up correctly will then appear on the thermostat display.

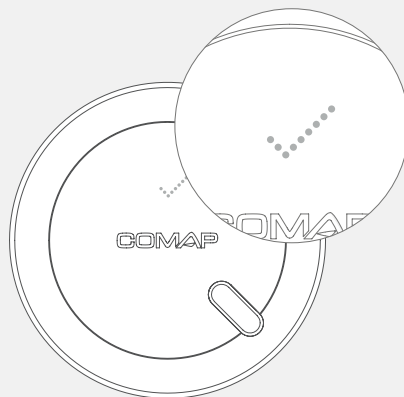

3 Switch off the power

Cut off the general power to avoid any risk of electric shock

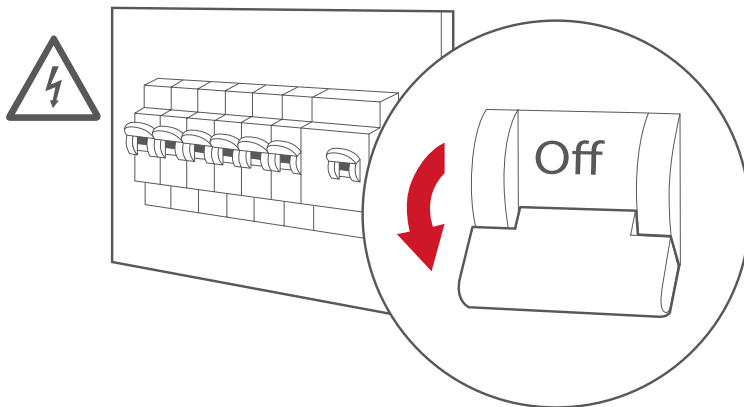

The following steps depend on your heating system :

ON/OFF CONTACT : REPLACING A 4 WIRES THERMOSTAT	12
ON/OFF CONTACT : First installation	18

ON/OFF CONTACT : REPLACING A 4 WIRES THERMOSTAT

GAS, OIL, WOOD, HEAT PUMP, ELECTRIC

4 Remove the front of your old thermostat

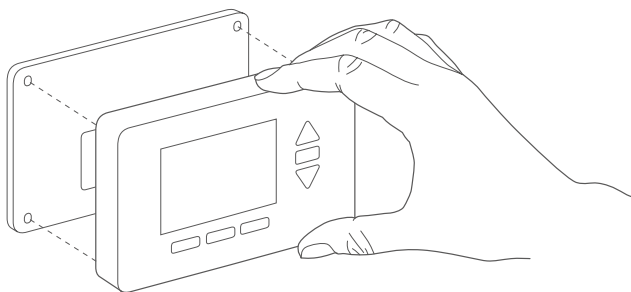

Check the number of connected wires :

- 4 wires: connect the heating module in the place of your old thermostat, see page 13
- 2/3 wires : your old thermostat is on batteries, the heating module will have to be connected to the boiler, see page 18

- 5 Disconnect your old thermostat**
Remove the base dock.

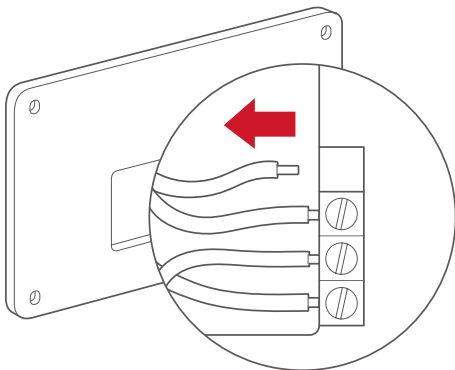

- 6 Detach your heating module by unclipping it from its base**

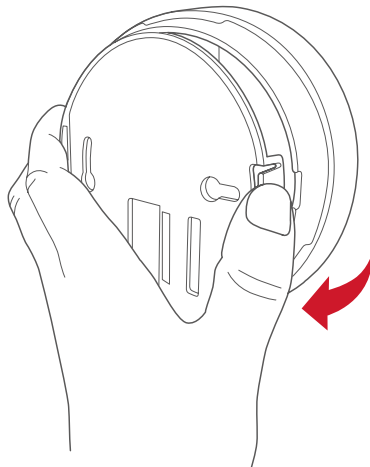

7 Open the protective cover

Use a Torx 8 screwdriver to remove the screw, run the wires through the opening in the base

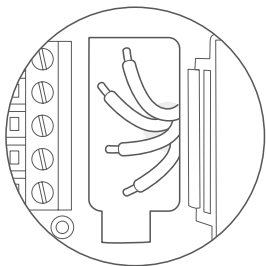
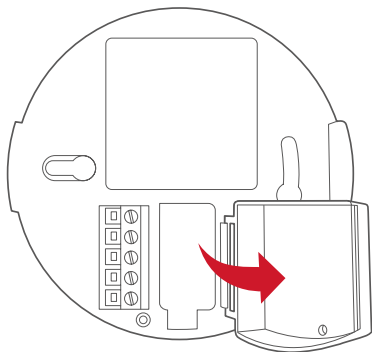

8 Connect the 4 wires to the wiring terminal

Usually the Phase wire (L) is red and Neutral wire (N) is blue.

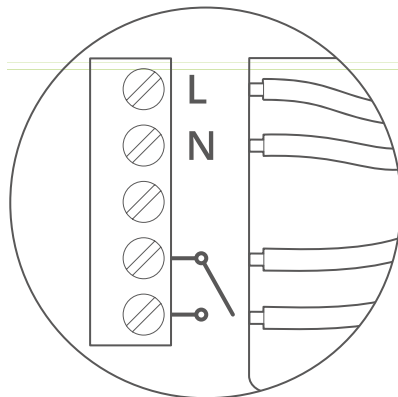

9 Fix the base of the heating module

Fix it with the screw anchors and screws.

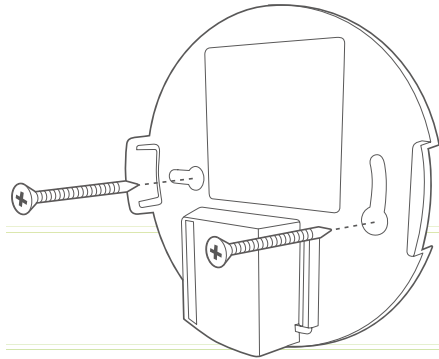

10 Turn the power back on

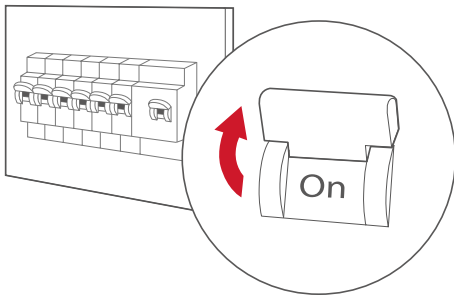

11 Close the heating module

- The power LED (left) is on and steady
- The connectivity LED (right) is flashing, the heating module is waiting to be paired with the thermostat



12 Check whether the heating part of your heating system is activated

13 Bring the thermostat close to the heating module

For your thermostat to communicate, it must be paired with the heating module. Place the thermostat on the heating module (or at a maximum distance of 5 centimetres)

14 Wake up the COMAP Smart Home thermostat

When the thermostat is activated, it displays a house symbol. When it has paired with the heating module, it will display, in this order :

- A double ended arrow <->
- The current temperature
- The temperature setpoint

The connectivity LED (right) on the heating module stops flashing and remains fixed

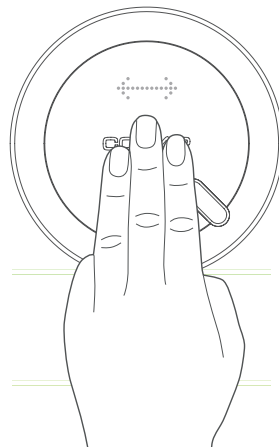

ON/OFF CONTACT : FIRST INSTALLATION

or replacement of a 2/3 wires thermostat

BOILER, STOVE, HEAT PUMP, CONTACTOR

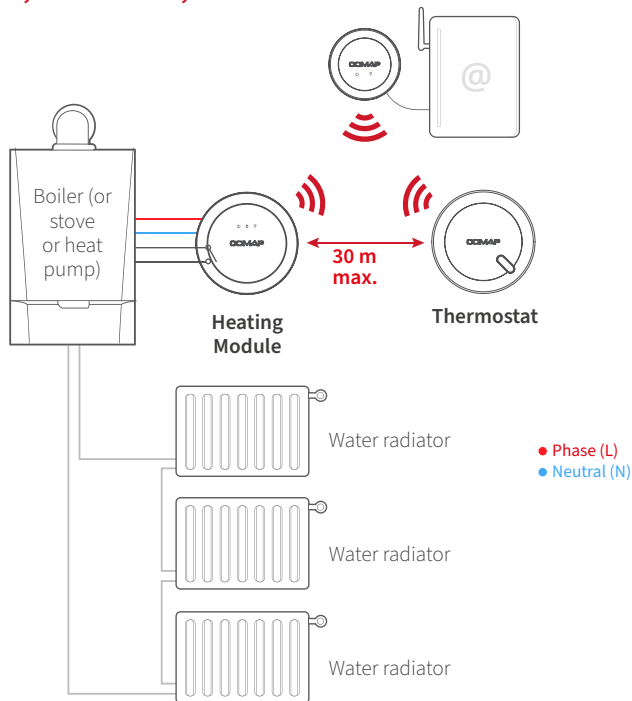

5 Connect the module to the heating system

To install it, open the protective cover of your boiler (using the manual if necessary). Find the wiring terminal of the room thermostat.

Connect terminals L (phase) and N (neutral) of the heating module to terminals L and N of the boiler or the terminal box. This will supply power to the heating module. Check the stripping distances of the cables and wires.

Connect the terminals of the on/off contact to the input for the on/off contact of the boiler (TA or LS-LR).

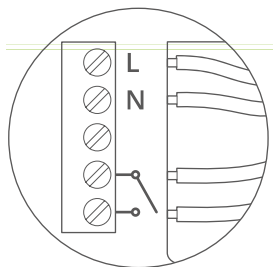

Connection block of the heating module

Note : Some thermostats are connected to an input other than the one listed above (eBus or EMS, for example). In this case, identify the thermostat input TA, LS-LR or RT24.

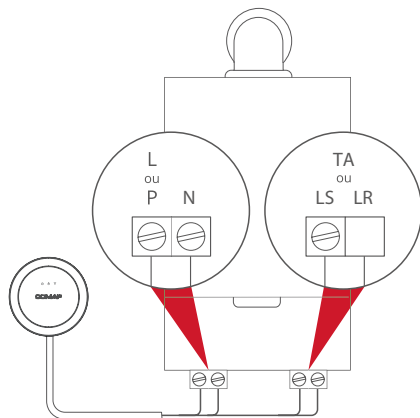

Input 220V

Wires are usually blue (N) and brown (L/P)

Room Thermostat

6 Attach the heating module base

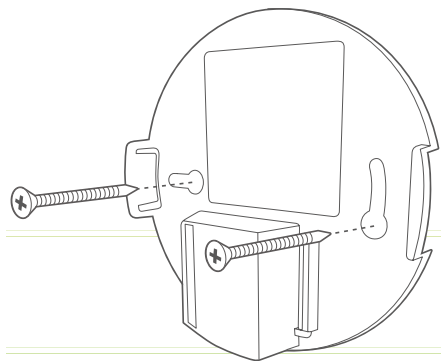

Note: if you are piloting electrical radiators, the current circuit of the potential-free contact must be adjusted to the capacity of the radiators being controlled. The required current for the control circuit must be less than 3A.

7 Turn the power back on

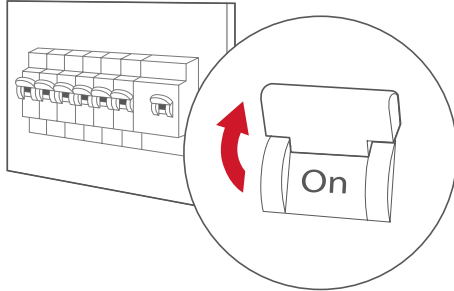

8 Close the heating module

- The power LED (left) is on and steady
- The connectivity LED (right) is flashing, the heating module is waiting to be paired with the thermostat

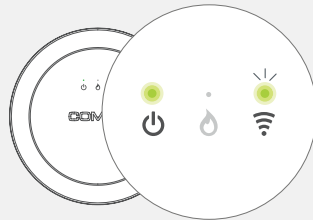

9 Check whether the heating part of your heating system is activated

10 Bring the thermostat close to the heating module

For your thermostat to communicate, it must be paired with the heating module. Place the thermostat on the heating module (or at a maximum distance of 5 centimetres)

11 Wake up the COMAP Smart Home thermostat

When the thermostat is activated, it displays a house symbol. When it has paired with the heating module, it will display, in this order :

- A double ended arrow <->
- The current temperature
- The temperature setpoint

The connectivity LED (right) on the heating module stops flashing and remains lit

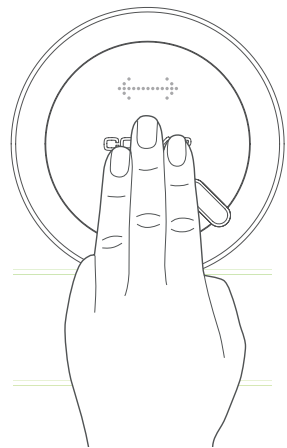

HEATING TEST

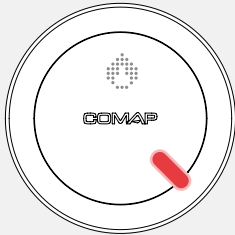

If necessary, you can perform a heating test by increasing the temperature using the arrow on the right:

- a flame will appear on the thermostat display and the sensor will turn red, indicating a heating command.



The heating light in the centre of the heating module must then light up.

Afterwards, do not forget to lower the temperature by pressing the left arrow on the thermostat.

ATTACH THE THERMOSTAT

- 1 Remove the thermostat base by unclipping it

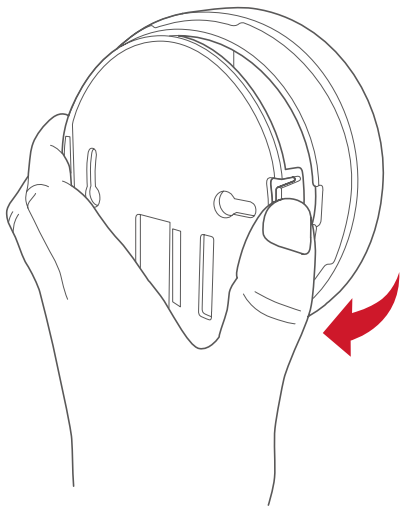

- 2 Fix the base to the wall using screws and wall anchors. Recommended locations see page 8

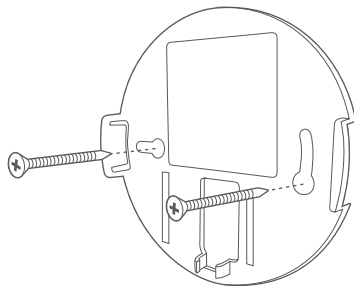

- 3 Place the thermostat on its base

**CONGRATULATIONS,
YOUR INSTALLATION IS COMPLETE.**



SPECIFICATIONS



Certificates and general terms and conditions

COMAP declares that the device is in compliance with the essential requirements and other relevant provisions of the R&TTE directive 1999/5/EC.

Wireless features

Connection of the gateway to the modem via USB 5V DC 200mA power supply and RJ45 Ethernet port.
Long-range wireless connection between the COMAP CSH thermostat, the heating module and the gateway (868 Mhz - 6LOWPAN protocol)

Thermostat sensors and measurements

High-precision temperature sensor
Measuring range: 0°C to 50°C
Sensitivity: +/- 0.05°C
Temperature (set point): 7°C to 25°C
Increase: 0.5°C
Presence sensor with wide field
Humidity sensor

Heating module

Operating temperature: 0 to 55°C.
Power supply 230V~, 50Hz.
Power consumption: 200mA
The cross-section of the cables to be connected must be between 0.75 mm² and 2.5 mm².
Version with control wire: The heating module must be protected by a circuit breaker of max. 2 A.
Version with on/off contact: The heating module must be protected by a circuit breaker with an output of max. 2 A.
Contamination level: 2
Nominal pulse voltage: 2500V
Automatic action: type 1
Maximum current of the dry contact: 3A

Required material

Modem with one RJ45 port and one free USB port.
Without a USB port, a USB charger is required (not included).

Dimensions

Thermostat: 110x110x25mm
Heating module: 110x110x25mm
Gateway: 82x82x23mm

Design

Design: 5.5 Design Studio
LED display
Touch interface
Heat indicator
2-year guarantee

Warnings

The thermostat, heating module and gateway are intended for indoor use only.
The heating module and the gateway must be installed in accordance with the applicable standards.
Use 3 LR3 - AAA batteries to power the thermostat. Do not use rechargeable batteries.
Keep children away from batteries. If swallowed, seek medical advice immediately.
Do not attempt to repair this device yourself, an after-sales service is available.
Any changes or modifications not expressly approved in these instructions will invalidate any guarantee claims.
Heating module: Insulation class II
Gateway: Insulation class III



Please do not hesitate to contact us,
our staff will be happy to help you:



FAQ : <http://support.comapsmarthome.com>



Email : contact@comapsmarthome.com